

LV570M Specialized for the Hospital Environment



HEALTHCARE

- ▶ **43LV570M**
43" class (42.5" diagonal)
- ▶ **32LV570M**
32" class (31.5" diagonal)
- ▶ **28LV570M**
28" class (27.6" diagonal)
- ▶ **24LV570M**
24" class (23.6" diagonal)



Safe and Convenient for All Users

HOSPITAL SAFETY STANDARD COMPLIANT



UL listed Mark

CONVENIENT FOR PATIENTS AND HOSPITAL STAFF



Nurse Call System

Pillow Speaker

EASY MANAGEMENT



Pro:Centric®

Easy Setup

USB Configuration

Specifications

Designed Specifically for the Healthcare Industry

UL Hospital Grade Listed

ENERGY STAR® Qualified

RoHS Compliant

California Energy Commission (CEC) Compliant

Multi IR Code Support

Built-in MPI Port

TV Speaker Disable

Built-In Pillow Speaker Compatibility
Supports multiple codes (Zenith, Philips, RCA)

First Use Wizard

LG's Exclusive Pro:Centric Application Platform

Supports Java™ and Adobe® Flash® Application
(Pro:Centric Single Tuner)

Remote Management of Television
Using Pro:Centric server

Dynamic/Static Power Savings

Restriction of Hazardous Substances

Integrated Pro:Idiom® Digital Rights Management Technology

MPEG-2 / MPEG-4 H.264 Decoding

Splash Screen Image/Logo (On Startup)

Customized Welcome Screen
(Pro:Centric application feature)

USB Cloning

On-site 2 Year Limited Warranty (parts and labor)

TV Stand: Not Included

OPTIMIZED FOR HOSPITAL ENVIRONMENT

Pillow Speaker Ready

Audio and video are controlled directly by a pillow speaker for patient convenience.



Nurse Call System

Hospital staff can be called in emergency situations.



UL Listed Mark

The LV570M series is UL certified healthcare grade.



EASY CONTENT CREATION & MANAGEMENT

Pro:Idiom®

Global Leading Digital Rights Management System

The most widely used DRM system prevents the illegal copying of content.

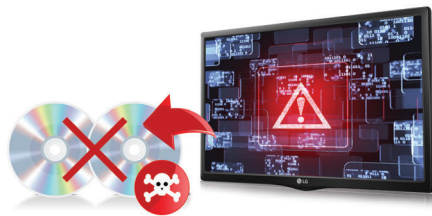

Pro:Idiom unlocks access to premium content to help assure rapid and broad deployment of HDTV and other high value digital content.

Pro:Idiom has been designed specifically for users of premium HDTV content from cable, satellite, or video on demand (VOD) services, and is thus designed to lower costs and reduce maintenance needs. This leading DRM system is embraced for its security solution, which prevents illegal copying of copyrighted content.

Reduced Total Cost of Ownership



The EZ-Manager's auto configuration function makes installation quick and easy. The EZ-Manager guides the installer to set up the TV with simple steps, saving time and cost.



Using LG's optional Pro:Centric server, you can remotely manage configuration and channel mapping for TVs in patient rooms without having to visit each room.

Effectively Manage Patient Room TVs



The USB Cloning feature allows you to simply copy settings from a designated Master TV using a USB memory device, a process that is fully automated to save time.

Pro:Centric®

Pro:Centric Application Platform

Interactive Patient Room Experience

An industry leading television that supports the Pro:Centric platform, LG's new LV570M allows healthcare facilities to customize the patient room experience. The Pro:Centric application allows you to create your own content and manage multiple channels, which can be specialized for your hospital. Pro:Centric also provides an easy way for the LV570M to interface with interactive program guides, games and internet data feeds, as well as applications designed to connect patients to services, such as dietary menus and patient room information.*



* May require additional software and hardware to support third-party partner interactive systems or LG's Free-To-Guest Mode/Pro:Centric application.

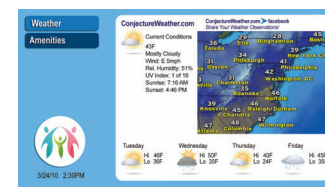

Customizable Pages

Up to 40 customizable billboard and/or map pages.

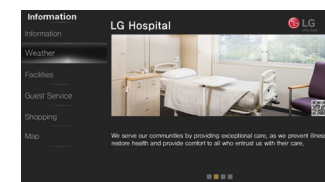

Multi Channel Spooling

Operation of up to eight customizable video channels.

OPTIONAL ACCESSORY REMOTES

INSTALLER REMOTE



PATIENT MULTI-BED REMOTE



PRO:CENTRIC PILLOW SPEAKER



DIMENSION

43LV570M | 32LV570M

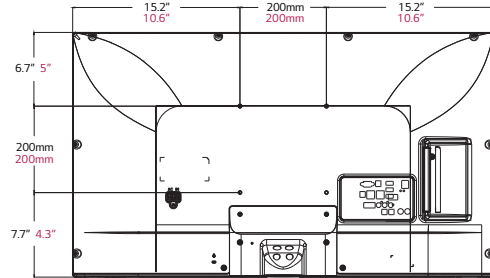
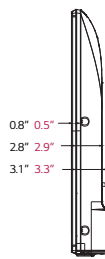
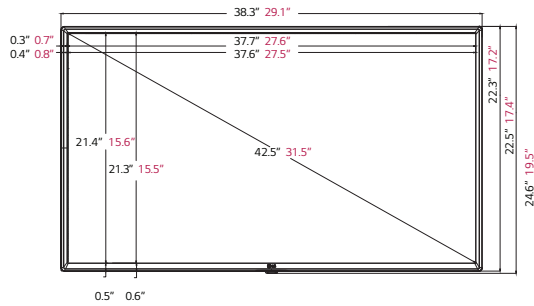

28LV570M | 24LV570M

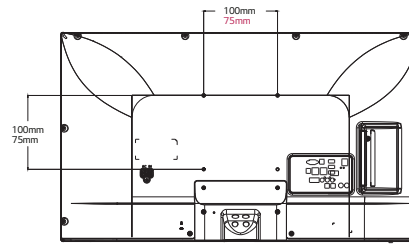
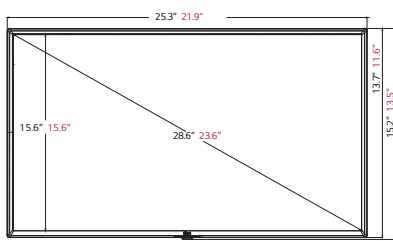

JACK PACK

43LV570M | 32LV570M

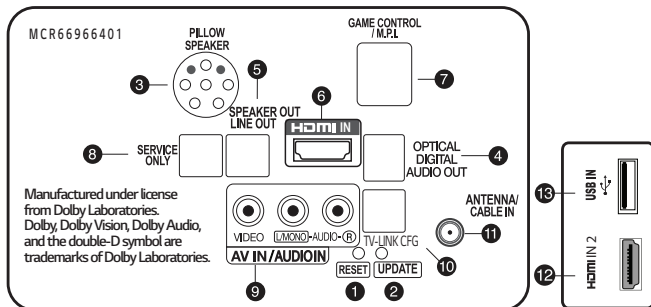

- 1 RESET
- 2 UPDATE
- 3 PILLOW SPEAKER
- 4 OPTICAL AUDIO OUT
- 5 SPEAKER OUT / LINE OUT
- 6 HDMI IN
- 7 GAME CONTROL / M.P.I.
- 8 SERVICE ONLY
- 9 AV IN / AUDIO IN
- 10 TV-LINK CFG
- 11 ANTENNA / CABLE IN
- 12 HDMI IN 2
- 13 USB IN

28LV570M | 24LV570M

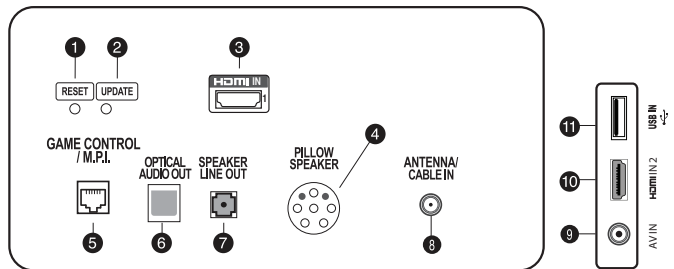

- 1 RESET
- 2 UPDATE
- 3 HDMI IN 1
- 4 PILLOW SPEAKER
- 5 GAME CONTROL / M.P.I.
- 6 OPTICAL AUDIO OUT
- 7 SPEAKER OUT / LINE OUT
- 8 ANTENNA / CABLE IN
- 9 AV IN
- 10 HDMI IN 2
- 11 USB IN

LV570M

Specialized for the Hospital Environment

▶ **43LV570M**

43" class (42.5" diagonal)

▶ **28LV570M**

28" class (27.6" diagonal)

▶ **32LV570M**

32" class (31.5" diagonal)

▶ **24LV570M**

24" class (23.6" diagonal)



PANEL	MODEL NAME	43LV570M	32LV570M	28LV570M	24LV570M
Backlight Type		Direct LED		Edge LED	
	Resolution	1920 x 1080 (FHD)		1366 x 768 (HD)	
Static (Panel) Contrast Ratio		1,100 : 1		1,000 : 1	3,000 : 1
	Viewing Angle	178x178			
Response Time (G to G, ms)		9 ms		8 ms	
	Frame Rate	60 Hz			
BROADCASTING SYSTEM	Analog	Yes (NTSC)			
	Digital	Yes (ATSC)			
	Terrestrial	VSB			
	Cable	Clear QAM/VSB			
VIDEO	XD Engine	Yes			
	Real Cinema 24p (3:3 pull down)	Yes			
	Picture Mode	Yes 5 modes (Vivid, Standard, APS, Cinema, Sports, Game)			
	Aspect Ratio	Yes 5 modes (16:9, Just Scan, Set By Program, 4:3, Zoom)			
AUDIO	Audio Output	10W + 10W	5W + 5W		
	Speaker System	2.0 ch			
	Sound Mode	Yes 6 modes (Standard, News, Music, Cinema, Sport, Game)			
	Optical Sound Sync	Yes			
Clear Voice		Yes			
	RF	Yes (1 Tuner)			
PRO-CENTRIC SMART	HCAP (GEM/FLASH/HTML) Service Carousel (TLL/XML)	GEM / Flash			
	PRO-CENTRIC V	Pro:Centric Application (version)	Yes (PCA3.7.5)		
PRO-CENTRIC SERVER	PCS200S	Yes			
DRM	Pro:Idiom	Yes			
EASE INSTALLATION	First Use Wizard	Yes			
	USB Cloning	Yes			
MANAGEMENT	Wake on RF	Yes			
	Self Diagnostics	Yes (USB)			
	SI Compatible (TVLink Interactive)	Yes (MPI protocol)			
	b-LAN	Yes			
	HTNG-CEC	Yes			
	HDMI-CEC	Yes (Without ARC)			
	IR Out	Yes (MPI Jack)			
	Multi IR Code	Yes			
	Installer Menu	Yes			
	Welcome Screen (Splash Image)	Yes			
HOSPITALITY FEATURE	One Channel Map	Yes (LCM)			
	External Speaker Out	Yes (Variable/Fixed/Line Out, 3.5mm, Stereo, Single ended Type (GND,L+,R+), W with 8Ω)			
	Instant On	Yes			
	RJP Interface	Yes (RJ45,HDMI)			
RJP Compatibility		Yes, Teleadapt (RJ45, HDMI-CEC), Teleadapt/Guestlink (HDMI-CEC)			
	USB	Moving Picture Playback (SD/HD/Plus HD)	.asf, .wmv, .divx, .avi, .mp4, .m4v, .mov, .mpg, .mpeg, .mpe, etc.		
Picture		.jpg, .jpeg, .jpe, BMP, PNG			
Audio Codec		MP3, AAC, M4A, WMA, WMA 10 pro, OGG			

SETTING OPTION	MODEL NAME	43LV570M	32LV570M	28LV570M	24LV570M
Auto Off / Sleep Timer		Yes			
	Smart Energy Saving	Yes			
	Motion Eye Care	Yes			
SIDE	AV In	No		Yes	
	HDMI In	2 (1.4)			
	USB	1 (2.0)			
REAR	RF In	1 (b-LAN)			
	AV In	Yes		No	
	Digital Audio Out (Coaxial / Optical)	1 (Optical)			
	HDMI/HDCP Input	1 (1.4)			
	External Speaker Out (3.5mm phone jack)	1 (Spk-out & Line Out)			
	TV link Configuration (phone jack type)	1 (b_LAN Service)			
	MPI Port (RJ12 jack)	1			
	Debug (Phone Jack Type)	1 (Debug)			
	Pillow Speaker Interface (6pin)	1			
	DESIGN	Front Color	Black Coffee		Black
Flame Retardent		Yes			
VESA Compatible		200mm x 200mm		100mm x 100mm	75mm x 75mm
DIMENSION	Weight (w/o stand)	20.1lbs	10.8lbs	10.4lbs	7.7 lbs
	Weight (Packing)	24.5lbs	13.4lbs	13.4lbs	10.4lbs
	WxHxD (w/o stand)	38.3"x22.5"x2.8"	29.1"x17.4"x2.9"	25.3"x15.6"x2.3"	21.9"x13.5"x2.1"
	WxHxD (Packing)	41.7"x26.0"x6.0"	32.0"x20.1"x5.6"	28.5"x18.5"x6.0"	27.6"x15.8"x5.5"
	Bezel Width (Left/Right, Upper, Bottom) : on bezel	10,10,15.2 (mm)	14.8, 14.8, 17.7 (mm)	16.0, 15.4, 24.1 (mm)	16.3, 17.8, 22.3 (mm)
	Bezel Width (Left/Right, Upper, Bottom) : Off bezel	8.5, 8.5, 13.7 (mm)	13.0,13.0,15.8 (mm)	14.3, 13.7, 22.5 (mm)	14.6, 16.1, 20.7 (mm)
POWER	Voltage, Hz	120V, 50/60Hz			
	Typical (Watts) - Based on Energy Star Qualified	30.5	21.0	20.9	18.2
	Stand-by	<0.5W			
CERTIFICATION	Safety	UL			
	EMC	FCC			
	ETC.	RoHS, UL, NOM, Energy Star 7.0			
ACCESSORIES	Cable	Power cable (5.9ft, Angle Type)			
	Manual / ESG	Simple Manual			
OTHER	Warranty	2 Year Limited Warranty (Parts and Labor) Extended Warranties Available			
	UPC	7 19192 61189 4	7 19192 61190 0	7 19192 91982 2	7 19192 91981 5
COMPATIBLE INTERACTIVE SYSTEMS (SEPARATE SET-TOP BOX MAY BE REQUIRED)					

- http://www.lg.com/us/business/commercial-display
- http://www.twitter.com/LGCommDisplays
- http://www.facebook.com/LGcommercialdisplays
- http://www.linkedin.com/company/lg-commercial-displays-usa
- http://www.youtube.com/lgcommercialdisplayusa



LG Electronics U.S.A., Inc.
HE B2B Division
2000 Millbrook Drive
Lincolnshire, IL 60069
www.LG.com/us/commercial/display-support

Contact your LG Regional Sales Representative:
Healthcare: 877.793.6484
E-mail: info@LGSolutions.com

SPEC_LV570M_031802_PR



All screen images are simulated. Dimensions and weights are approximate. Design, features and specifications subject to change without notice.

©Copyright 2018 LG Electronics U.S.A. Inc. All Rights Reserved. Pro:Centric, the "LG" logo, XD Engine, and EcoSmart are registered trademarks or trademarks of LG Electronics Inc. Pro:Idiom is a registered trademark of Zenith Electronics LLC.

VESA is a trademark of Video Electronics Standards Association. HDMI, the HDMI Logo and High-Definition Multimedia Interface are trademarks or registered trademarks of HDMI Licensing LLC. Dolby and the double-D symbol are registered trademarks of Dolby Laboratories. Java is a trademark of Oracle, Inc. Adobe and Flash are either registered trademarks or trademarks of Adobe Systems Incorporated in the United States and/or other countries. b-LAN is a trademark of SONIFI Systems, Inc. All other product and brand names are trademarks or registered trademarks of their respective companies.

LED TV is LCD TV with LED backlighting